



154 557 C

2012-04

Processes



MIG (GMAW) Welding

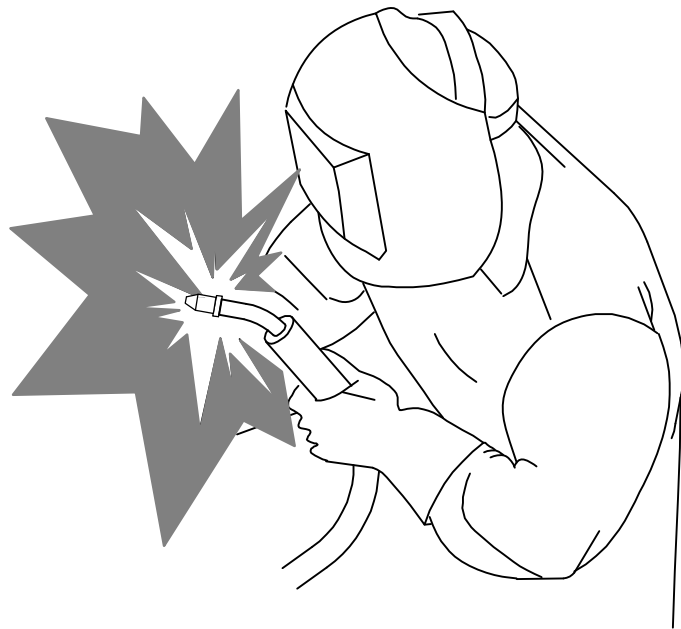

Guidelines For Gas Metal Arc Welding (GMAW)



Visit our website at
www.MillerWelds.com

TABLE OF CONTENTS

SECTION 1 – SAFETY PRECAUTIONS - READ BEFORE USING	1
1-1. Symbol Usage	1
1-2. Arc Welding Hazards	1
1-3. Additional Symbols For Installation, Operation, And Maintenance	3
1-4. California Proposition 65 Warnings	4
1-5. Principal Safety Standards	4
1-6. EMF Information	4
SECTION 2 – GAS METAL ARC WELDING (GMAW)	5
2-1. Typical GMAW Semiautomatic Setup With Constant Speed Feeder	6
2-2. Typical GMAW Semiautomatic Setup With Voltage-Sensing Feeder	7
2-3. Typical GMAW Process Control Settings	8
2-4. Holding And Positioning Welding Gun	9
2-5. Conditions That Affect Weld Bead Shape	10
2-6. Gun Movement During Welding	11
2-7. Poor Weld Bead Characteristics	11
2-8. Good Weld Bead Characteristics	12
2-9. Common GMAW Shielding Gases	12
SECTION 3 – MODES OF GMAW TRANSFER	13
3-1. Short Circuit Transfer	13
3-2. Globular Transfer	14
3-3. Spray Arc Transfer	14
SECTION 4 – GMAW WELDING TROUBLESHOOTING	15
4-1. Excessive Spatter	15
4-2. Porosity	15
4-3. Incomplete Fusion	16
4-4. Excessive Penetration	16
4-5. Lack Of Penetration	16
4-6. Burn Through	17
4-7. Waviness Of Bead	17
4-8. Distortion	17

SECTION 1 – SAFETY PRECAUTIONS - READ BEFORE USING

som 2011-10

 Protect yourself and others from injury — read, follow, and save these important safety precautions and operating instructions.

1-1. Symbol Usage



DANGER! – Indicates a hazardous situation which, if not avoided, will result in death or serious injury. The possible hazards are shown in the adjoining symbols or explained in the text.



Indicates a hazardous situation which, if not avoided, could result in death or serious injury. The possible hazards are shown in the adjoining symbols or explained in the text.

NOTICE – Indicates statements not related to personal injury.

 Indicates special instructions.



This group of symbols means Warning! Watch Out! ELECTRIC SHOCK, MOVING PARTS, and HOT PARTS hazards. Consult symbols and related instructions below for necessary actions to avoid the hazards.

1-2. Arc Welding Hazards



The symbols shown below are used throughout this manual to call attention to and identify possible hazards. When you see the symbol, watch out, and follow the related instructions to avoid the hazard. The safety information given below is only a summary of the more complete safety information found in the Safety Standards listed in Section 1-5. Read and follow all Safety Standards.



Only qualified persons should install, operate, maintain, and repair this unit.



During operation, keep everybody, especially children, away.



ELECTRIC SHOCK can kill.

Touching live electrical parts can cause fatal shocks or severe burns. The electrode and work circuit is electrically live whenever the output is on. The input power circuit and machine internal circuits are also live when power is on. In semiautomatic or automatic wire welding, the wire, wire reel, drive roll housing, and all metal parts touching the welding wire are electrically live. Incorrectly installed or improperly grounded equipment is a hazard.

- Do not touch live electrical parts.

- Wear dry, hole-free insulating gloves and body protection.
- Insulate yourself from work and ground using dry insulating mats or covers big enough to prevent any physical contact with the work or ground.
- Do not use AC output in damp areas, if movement is confined, or if there is a danger of falling.
- Use AC output ONLY if required for the welding process.
- If AC output is required, use remote output control if present on unit.
- Additional safety precautions are required when any of the following electrically hazardous conditions are present: in damp locations or while wearing wet clothing; on metal structures such as floors, gratings, or scaffolds; when in cramped positions such as sitting, kneeling, or lying; or when there is a high risk of unavoidable or accidental contact with the workpiece or ground. For these conditions, use the following equipment in order presented: 1) a semiautomatic DC constant voltage (wire) welder, 2) a DC manual (stick) welder, or 3) an AC welder with reduced open-circuit voltage. In most situations, use of a DC, constant voltage wire welder is recommended. And, do not work alone!
- Disconnect input power or stop engine before installing or servicing this equipment. Lockout/tagout input power according to OSHA 29 CFR 1910.147 (see Safety Standards).
- Properly install, ground, and operate this equipment according to its Owner's Manual and national, state, and local codes.

- Always verify the supply ground – check and be sure that input power cord ground wire is properly connected to ground terminal in disconnect box or that cord plug is connected to a properly grounded receptacle outlet.
- When making input connections, attach proper grounding conductor first – double-check connections.
- Keep cords dry, free of oil and grease, and protected from hot metal and sparks.
- Frequently inspect input power cord for damage or bare wiring – replace cord immediately if damaged – bare wiring can kill.
- Turn off all equipment when not in use.
- Do not use worn, damaged, undersized, or poorly spliced cables.
- Do not drape cables over your body.
- If earth grounding of the workpiece is required, ground it directly with a separate cable.
- Do not touch electrode if you are in contact with the work, ground, or another electrode from a different machine.
- Do not touch electrode holders connected to two welding machines at the same time since double open-circuit voltage will be present.
- Use only well-maintained equipment. Repair or replace damaged parts at once. Maintain unit according to manual.
- Wear a safety harness if working above floor level.
- Keep all panels and covers securely in place.
- Clamp work cable with good metal-to-metal contact to workpiece or worktable as near the weld as practical.
- Insulate work clamp when not connected to workpiece to prevent contact with any metal object.
- Do not connect more than one electrode or work cable to any single weld output terminal. Disconnect cable for process not in use.

SIGNIFICANT DC VOLTAGE exists in inverter welding power sources AFTER removal of input power.

- Turn Off inverter, disconnect input power, and discharge input capacitors according to instructions in Maintenance Section before touching any parts.



HOT PARTS can burn.

- Do not touch hot parts bare handed.
- Allow cooling period before working on equipment.
- To handle hot parts, use proper tools and/or wear heavy, insulated welding gloves and clothing to prevent burns.



FUMES AND GASES can be hazardous.

Welding produces fumes and gases. Breathing these fumes and gases can be hazardous to your health.

- Keep your head out of the fumes. Do not breathe the fumes.
- If inside, ventilate the area and/or use local forced ventilation at the arc to remove welding fumes and gases.
- If ventilation is poor, wear an approved air-supplied respirator.
- Read and understand the Material Safety Data Sheets (MSDSs) and the manufacturer's instructions for metals, consumables, coatings, cleaners, and degreasers.
- Work in a confined space only if it is well ventilated, or while wearing an air-supplied respirator. Always have a trained watch-person nearby. Welding fumes and gases can displace air and lower the oxygen level causing injury or death. Be sure the breathing air is safe.
- Do not weld in locations near degreasing, cleaning, or spraying operations. The heat and rays of the arc can react with vapors to form highly toxic and irritating gases.
- Do not weld on coated metals, such as galvanized, lead, or cadmium plated steel, unless the coating is removed from the weld area, the area is well ventilated, and while wearing an air-supplied respirator. The coatings and any metals containing these elements can give off toxic fumes if welded.



ARC RAYS can burn eyes and skin.

Arc rays from the welding process produce intense visible and invisible (ultraviolet and infrared) rays that can burn eyes and skin. Sparks fly off from the weld.

- Wear an approved welding helmet fitted with a proper shade of filter lenses to protect your face and eyes from arc rays and sparks when welding or watching (see ANSI Z49.1 and Z87.1 listed in Safety Standards).
- Wear approved safety glasses with side shields under your helmet.
- Use protective screens or barriers to protect others from flash, glare and sparks; warn others not to watch the arc.
- Wear protective clothing made from durable, flame-resistant material (leather, heavy cotton, or wool) and foot protection.



WELDING can cause fire or explosion.

Welding on closed containers, such as tanks, drums, or pipes, can cause them to blow up. Sparks can fly off from the welding arc. The flying sparks, hot workpiece, and hot equipment can cause fires and burns. Accidental contact of electrode to metal objects can cause sparks, explosion, overheating, or fire. Check and be sure the area is safe before doing any welding.

- Remove all flammables within 35 ft (10.7 m) of the welding arc. If this is not possible, tightly cover them with approved covers.
- Do not weld where flying sparks can strike flammable material.
- Protect yourself and others from flying sparks and hot metal.
- Be alert that welding sparks and hot materials from welding can easily go through small cracks and openings to adjacent areas.
- Watch for fire, and keep a fire extinguisher nearby.
- Be aware that welding on a ceiling, floor, bulkhead, or partition can cause fire on the hidden side.
- Do not weld on containers that have held combustibles, or on closed containers such as tanks, drums, or pipes unless they are properly prepared according to AWS F4.1 and AWS A6.0 (see Safety Standards).
- Do not weld where the atmosphere may contain flammable dust, gas, or liquid vapors (such as gasoline).
- Connect work cable to the work as close to the welding area as practical to prevent welding current from traveling long, possibly unknown paths and causing electric shock, sparks, and fire hazards.
- Do not use welder to thaw frozen pipes.

- Remove stick electrode from holder or cut off welding wire at contact tip when not in use.
- Wear oil-free protective garments such as leather gloves, heavy shirt, cuffless trousers, high shoes, and a cap.
- Remove any combustibles, such as a butane lighter or matches, from your person before doing any welding.
- After completion of work, inspect area to ensure it is free of sparks, glowing embers, and flames.
- Use only correct fuses or circuit breakers. Do not oversize or bypass them.
- Follow requirements in OSHA 1910.252 (a) (2) (iv) and NFPA 51B for hot work and have a fire watcher and extinguisher nearby.

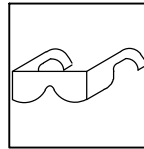

FLYING METAL or DIRT can injure eyes.

- Welding, chipping, wire brushing, and grinding cause sparks and flying metal. As welds cool, they can throw off slag.
- Wear approved safety glasses with side shields even under your welding helmet.



BUILDUP OF GAS can injure or kill.

- Shut off compressed gas supply when not in use.
- Always ventilate confined spaces or use approved air-supplied respirator.

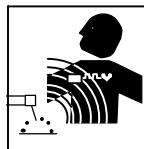

ELECTRIC AND MAGNETIC FIELDS (EMF) can affect Implanted Medical Devices.

- Wearers of Pacemakers and other Implanted Medical Devices should keep away.
- Implanted Medical Device wearers should consult their doctor and the device manufacturer before going near arc welding, spot welding, gouging, plasma arc cutting, or induction heating operations.

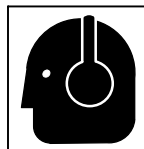

NOISE can damage hearing.

Noise from some processes or equipment can damage hearing.

- Wear approved ear protection if noise level is high.

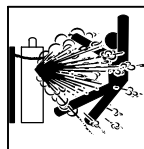

CYLINDERS can explode if damaged.

Compressed gas cylinders contain gas under high pressure. If damaged, a cylinder can explode. Since gas cylinders are normally part of the welding process, be sure to treat them carefully.

- Protect compressed gas cylinders from excessive heat, mechanical shocks, physical damage, slag, open flames, sparks, and arcs.
- Install cylinders in an upright position by securing to a stationary support or cylinder rack to prevent falling or tipping.
- Keep cylinders away from any welding or other electrical circuits.
- Never drape a welding torch over a gas cylinder.
- Never allow a welding electrode to touch any cylinder.
- Never weld on a pressurized cylinder – explosion will result.
- Use only correct compressed gas cylinders, regulators, hoses, and fittings designed for the specific application; maintain them and associated parts in good condition.
- Turn face away from valve outlet when opening cylinder valve.
- Keep protective cap in place over valve except when cylinder is in use or connected for use.
- Use the right equipment, correct procedures, and sufficient number of persons to lift and move cylinders.
- Read and follow instructions on compressed gas cylinders, associated equipment, and Compressed Gas Association (CGA) publication P-1 listed in Safety Standards.

1-3. Additional Symbols For Installation, Operation, And Maintenance



FIRE OR EXPLOSION hazard.

- Do not install or place unit on, over, or near combustible surfaces.
- Do not install unit near flammables.
- Do not overload building wiring – be sure power supply system is properly sized, rated, and protected to handle this unit.



FALLING EQUIPMENT can injure.

- Use lifting eye to lift unit only, NOT running gear, gas cylinders, or any other accessories.
- Use equipment of adequate capacity to lift and support unit.
- If using lift forks to move unit, be sure forks are long enough to extend beyond opposite side of unit.
- Keep equipment (cables and cords) away from moving vehicles when working from an aerial location.
- Follow the guidelines in the Applications Manual for the Revised NIOSH Lifting Equation (Publication No. 94-110) when manually lifting heavy parts or equipment.

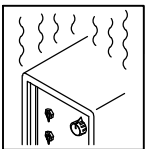

OVERUSE can cause OVERHEATING

- Allow cooling period; follow rated duty cycle.
- Reduce current or reduce duty cycle before starting to weld again.
- Do not block or filter airflow to unit.

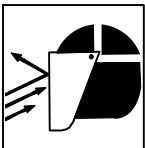

FLYING SPARKS can injure.

- Wear a face shield to protect eyes and face.
- Shape tungsten electrode only on grinder with proper guards in a safe location wearing proper face, hand, and body protection.
- Sparks can cause fires — keep flammables away.

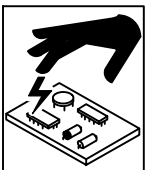

STATIC (ESD) can damage PC boards.

- Put on grounded wrist strap BEFORE handling boards or parts.
- Use proper static-proof bags and boxes to store, move, or ship PC boards.



MOVING PARTS can injure.

- Keep away from moving parts.
- Keep away from pinch points such as drive rolls.



WELDING WIRE can injure.

- Do not press gun trigger until instructed to do so.
- Do not point gun toward any part of the body, other people, or any metal when threading welding wire.

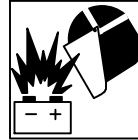

BATTERY EXPLOSION can injure.

- Do not use welder to charge batteries or jump start vehicles unless it has a battery charging feature designed for this purpose.



MOVING PARTS can injure.

- Keep away from moving parts such as fans.
- Keep all doors, panels, covers, and guards closed and securely in place.
- Have only qualified persons remove doors, panels, covers, or guards for maintenance and troubleshooting as necessary.
- Reinstall doors, panels, covers, or guards when maintenance is finished and before reconnecting input power.

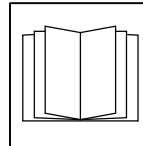

READ INSTRUCTIONS.

- Read and follow all labels and the Owner's Manual carefully before installing, operating, or servicing unit. Read the safety information at the beginning of the manual and in each section.
- Use only genuine replacement parts from the manufacturer.
- Perform maintenance and service according to the Owner's Manuals, industry standards, and national, state, and local codes.

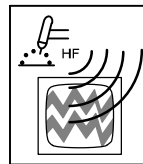

H.F. RADIATION can cause interference.

- High-frequency (H.F.) can interfere with radio navigation, safety services, computers, and communications equipment.
- Have only qualified persons familiar with electronic equipment perform this installation.
- The user is responsible for having a qualified electrician promptly correct any interference problem resulting from the installation.
- If notified by the FCC about interference, stop using the equipment at once.
- Have the installation regularly checked and maintained.
- Keep high-frequency source doors and panels tightly shut, keep spark gaps at correct setting, and use grounding and shielding to minimize the possibility of interference.

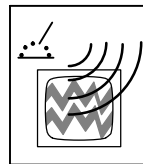

ARC WELDING can cause interference.

- Electromagnetic energy can interfere with sensitive electronic equipment such as computers and computer-driven equipment such as robots.
- Be sure all equipment in the welding area is electromagnetically compatible.
- To reduce possible interference, keep weld cables as short as possible, close together, and down low, such as on the floor.
- Locate welding operation 100 meters from any sensitive electronic equipment.
- Be sure this welding machine is installed and grounded according to this manual.
- If interference still occurs, the user must take extra measures such as moving the welding machine, using shielded cables, using line filters, or shielding the work area.

1-4. California Proposition 65 Warnings

 **Welding or cutting equipment produces fumes or gases which contain chemicals known to the State of California to cause birth defects and, in some cases, cancer. (California Health & Safety Code Section 25249.5 et seq.)**

 **This product contains chemicals, including lead, known to the state of California to cause cancer, birth defects, or other reproductive harm. Wash hands after use.**

1-5. Principal Safety Standards

Safety in Welding, Cutting, and Allied Processes, ANSI Standard Z49.1, is available as a free download from the American Welding Society at <http://www.aws.org> or purchased from Global Engineering Documents (phone: 1-877-413-5184, website: www.global.ihs.com).

Safe Practices for the Preparation of Containers and Piping for Welding and Cutting, American Welding Society Standard AWS F4.1, from Global Engineering Documents (phone: 1-877-413-5184, website: www.global.ihs.com).

Safe Practices for Welding and Cutting Containers that have Held Combustibles, American Welding Society Standard AWS A6.0, from Global Engineering Documents (phone: 1-877-413-5184, website: www.global.ihs.com).

National Electrical Code, NFPA Standard 70, from National Fire Protection Association, Quincy, MA 02269 (phone: 1-800-344-3555, website: www.nfpa.org and www.sparky.org).

Safe Handling of Compressed Gases in Cylinders, CGA Pamphlet P-1, from Compressed Gas Association, 14501 George Carter Way, Suite 103, Chantilly, VA 20151 (phone: 703-788-2700, website: www.cganet.com).

Safety in Welding, Cutting, and Allied Processes, CSA Standard W117.2, from Canadian Standards Association, Standards Sales, 5060

Spectrum Way, Suite 100, Ontario, Canada L4W 5NS (phone: 800-463-6727, website: www.csa-international.org).

Safe Practice For Occupational And Educational Eye And Face Protection, ANSI Standard Z87.1, from American National Standards Institute, 25 West 43rd Street, New York, NY 10036 (phone: 212-642-4900, website: www.ansi.org).

Standard for Fire Prevention During Welding, Cutting, and Other Hot Work, NFPA Standard 51B, from National Fire Protection Association, Quincy, MA 02269 (phone: 1-800-344-3555, website: www.nfpa.org).

OSHA, Occupational Safety and Health Standards for General Industry, Title 29, Code of Federal Regulations (CFR), Part 1910, Subpart Q, and Part 1926, Subpart J, from U.S. Government Printing Office, Superintendent of Documents, P.O. Box 371954, Pittsburgh, PA 15250-7954 (phone: 1-866-512-1800) (there are 10 OSHA Regional Offices—phone for Region 5, Chicago, is 312-353-2220, website: www.osha.gov).

Applications Manual for the Revised NIOSH Lifting Equation, The National Institute for Occupational Safety and Health (NIOSH), 1600 Clifton Rd, Atlanta, GA 30333 (phone: 1-800-232-4636, website: www.cdc.gov/NIOSH).

1-6. EMF Information

Electric current flowing through any conductor causes localized electric and magnetic fields (EMF). Welding current creates an EMF field around the welding circuit and welding equipment. EMF fields may interfere with some medical implants, e.g. pacemakers. Protective measures for persons wearing medical implants have to be taken. For example, restrict access for passers-by or conduct individual risk assessment for welders. All welders should use the following procedures in order to minimize exposure to EMF fields from the welding circuit:

1. Keep cables close together by twisting or taping them, or using a cable cover.
2. Do not place your body between welding cables. Arrange cables to one side and away from the operator.
3. Do not coil or drape cables around your body.

4. Keep head and trunk as far away from the equipment in the welding circuit as possible.
5. Connect work clamp to workpiece as close to the weld as possible.
6. Do not work next to, sit or lean on the welding power source.
7. Do not weld whilst carrying the welding power source or wire feeder.

About Implanted Medical Devices:

Implanted Medical Device wearers should consult their doctor and the device manufacturer before performing or going near arc welding, spot welding, gouging, plasma arc cutting, or induction heating operations. If cleared by your doctor, then following the above procedures is recommended.

SECTION 2 – GAS METAL ARC WELDING (GMAW)

Gas Metal Arc Welding (GMAW) is a welding process which joins metals by heating the metals to their melting point with an electric arc. The arc is between a continuous, consumable electrode wire and the metal being welded. The arc is shielded from contaminants in the atmosphere by a shielding gas.

GMAW can be done in three different ways:

- Semiautomatic Welding - equipment controls only the electrode wire feeding. Movement of welding gun is controlled by hand. This may be called hand-held welding.
- Machine Welding - uses a gun that is connected to a manipulator of some kind (not hand-held). An operator has to constantly set and adjust controls that move the manipulator.
- Automatic Welding - uses equipment which welds without the constant adjusting of controls by a welder or operator. On some equipment, automatic sensing devices control the correct gun alignment in a weld joint.

Basic equipment for a typical GMAW semiautomatic setup:

- Welding Power Source - provides welding power.
- Wire Feeders (Constant Speed And Voltage-Sensing) - controls supply of wire to welding gun.

Constant Speed Feeder - Used only with a constant voltage (CV) power source. This type of feeder has a control cable that will connect to the power source. The control cable supplies power to the feeder and allows the capability of remote voltage control with certain power source/feeder combinations. The wire feed speed (WFS) is set on the feeder and will always be constant for a given preset value.

Voltage-Sensing Feeder - Can be used with either a constant voltage (CV) or constant current (CC) - direct current (DC) power source. This type of feeder is powered off of the arc voltage and does not have a control cord. When set to (CV), the feeder is similar to a constant speed feeder. When set to (CC), the wire feed speed depends on the voltage present. The feeder changes the wire feed speed as the voltage changes. A voltage sensing feeder does not have the capability of remote voltage control.

- Supply of Electrode Wire.
- Welding Gun - delivers electrode wire and shielding gas to the weld puddle.
- Shielding Gas Cylinder - provides a supply of shielding gas to the arc.

2-1. Typical GMAW Semiautomatic Setup With Constant Speed Feeder



- 1 Constant Voltage (CV) Welding Power Source
- 2 Contactor Control/Power Cord
- 3 Weld Cable To Feeder
- 4 Ground Cable To Workpiece
- 5 Workpiece
- 6 Welding Gun
- 7 Constant Speed Wire Feeder
- 8 Electrode Wire
- 9 Gas Hose
- 10 Shielding Gas Cylinder

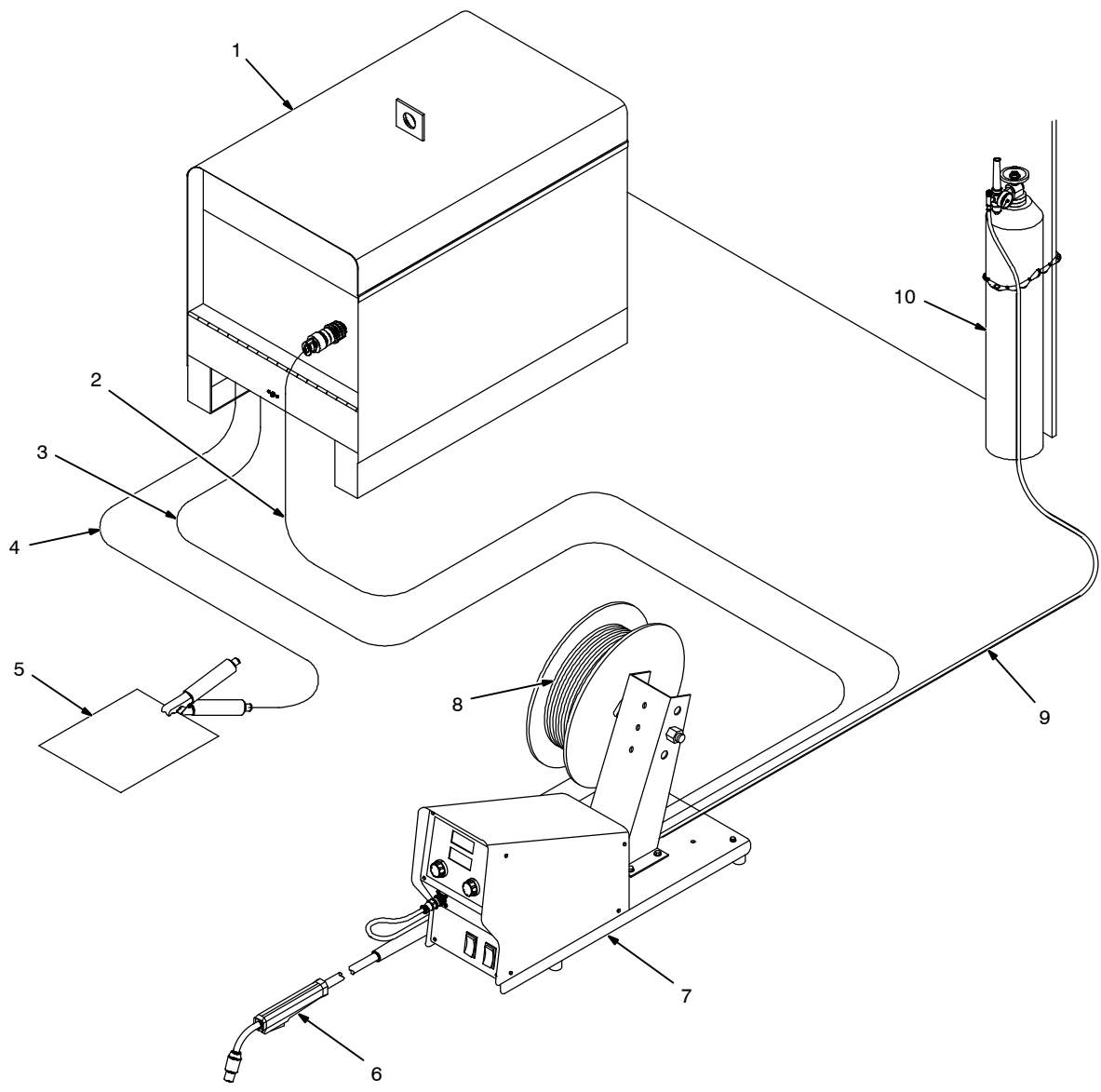

2-2. Typical GMAW Semiautomatic Setup With Voltage-Sensing Feeder

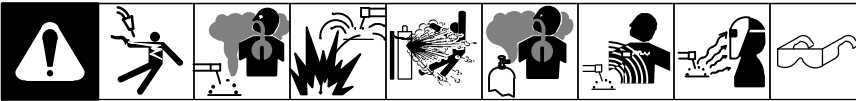

- 1 Constant Current (CC-DC) Or Constant Voltage (CV) Welding Power Source
- 2 Weld Cable To Feeder
- 3 Ground Cable To Workpiece
- 4 Workpiece
- 5 Voltage-Sensing Clamp
- 6 Welding Gun
- 7 Gun Trigger Receptacle
- 8 Voltage-Sensing Wire Feeder
- 9 Gas Hose
- 10 Shielding Gas Cylinder

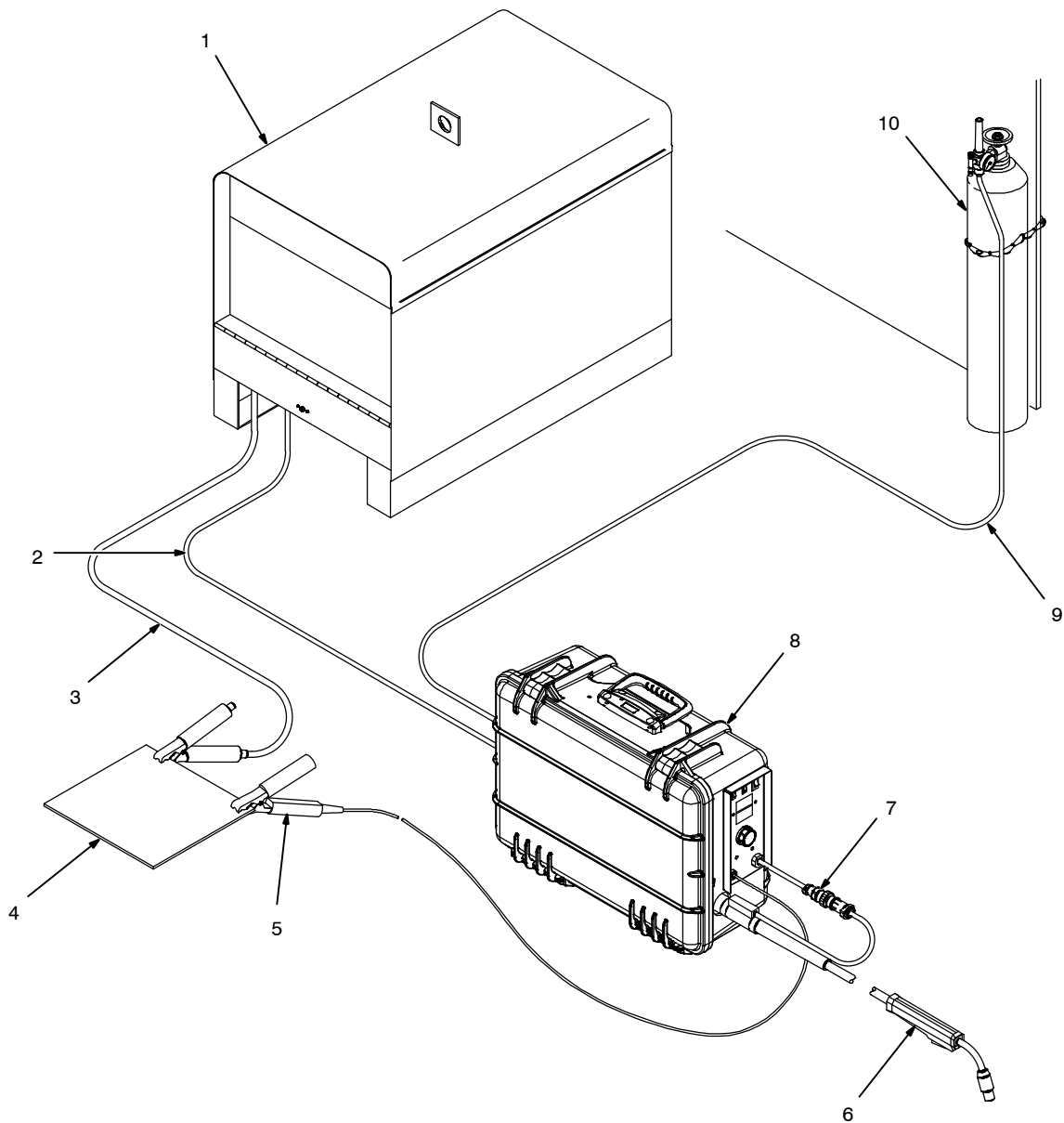

2-3. Typical GMAW Process Control Settings

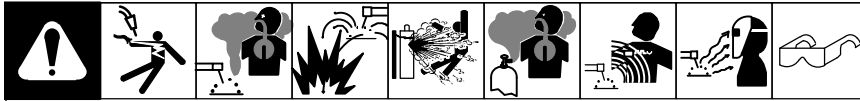

☞ *These settings are guidelines only. Material and wire type, joint design, fit-up, position, shielding gas, etc. affect settings. Test welds to be sure they comply to specifications.*

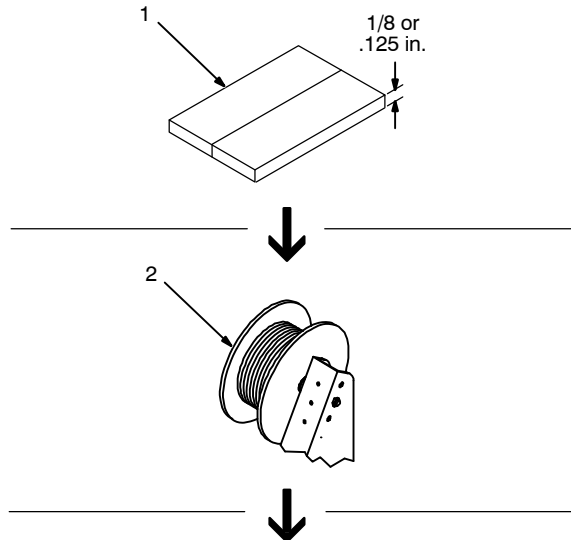

- 1 Convert Material Thickness to Amperage (A)
(.001 in. = 1 ampere)
.125 = 125 A

☞ *Material thickness determines weld parameters.*

- 2 Select Wire Size

Wire Size	Amperage Range
.030 in.	40 – 145 A
.035 in.	50 – 180 A
.045 in.	75 – 250 A

- 3 Select Wire Speed (Amperage)

125 A based on 1/8 in. (3 mm) material thickness.
(ipm = inch per minute)

Wire Size	Suggested	Wire Speed (Approx.)
.030 in.	2 in. per amp	2 x 125 A = 250 IPM
.035 in.	1.6 in. per amp	1.6 x 125 A = 200 IPM
.045 in.	1 in. per amp	1 x 125 A = 125 IPM

☞ *Wire speed (amperage) controls weld penetration (wire speed = burn-off rate).*

- 4 Select Voltage

Low Voltage: wire stubs into work
High Voltage: arc is unstable (spatter)

Set voltage midway between high/low voltage.

☞ *Voltage controls height and width of weld bead.*

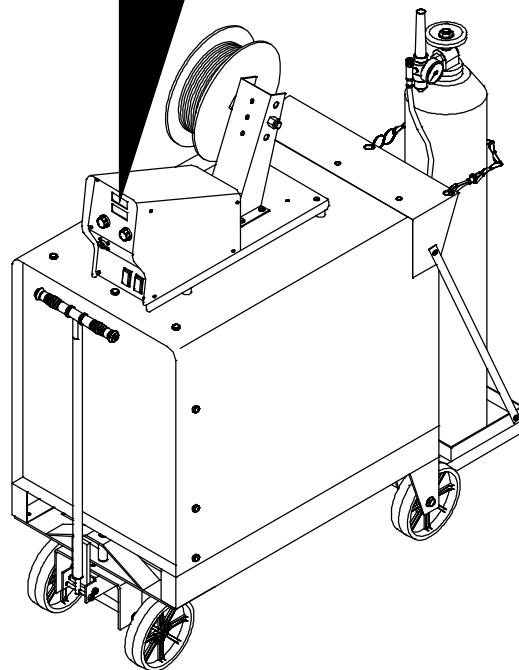
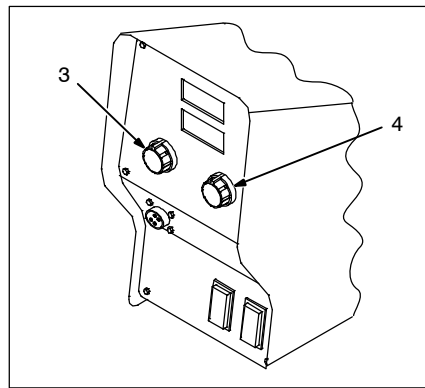

2-4. Holding And Positioning Welding Gun

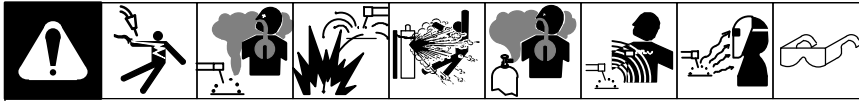

☞ *Welding wire is energized when gun trigger is pressed. Before lowering helmet and pressing trigger, be sure wire is no more than 1/2 in. (13 mm) past end of nozzle, and tip of wire is positioned correctly on seam.*

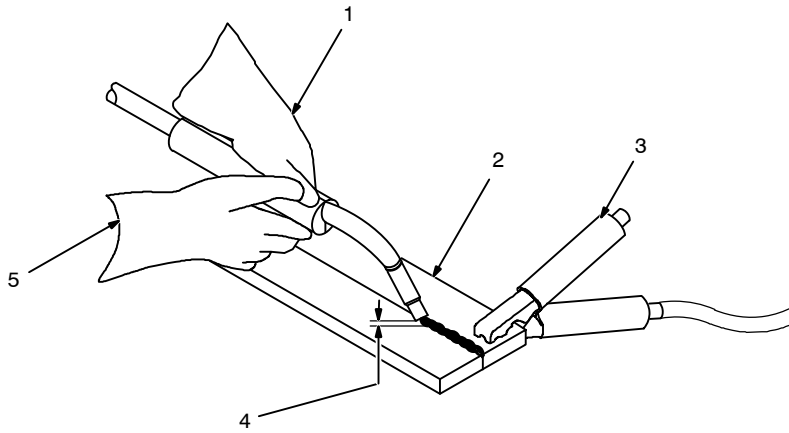

- 1 Hold Gun And Control Gun Trigger
- 2 Workpiece
- 3 Work Clamp
- 4 Electrode Extension (Stickout) 1/4 To 1/2 in. (6 To 13 mm)
- 5 Cradle Gun And Rest Hand On Workpiece

Groove Welds

- 6 End View Of Work Angle
- 7 Side View Of Gun Angle

Fillet Welds

- 8 End View Of Work Angle
- 9 Side View Of Gun Angle

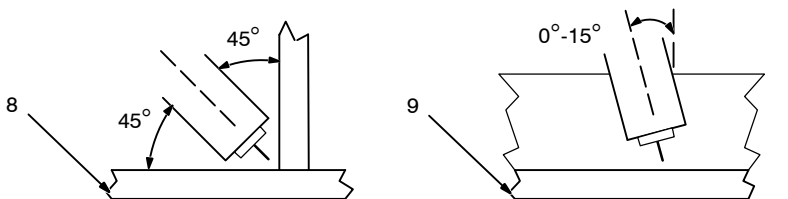
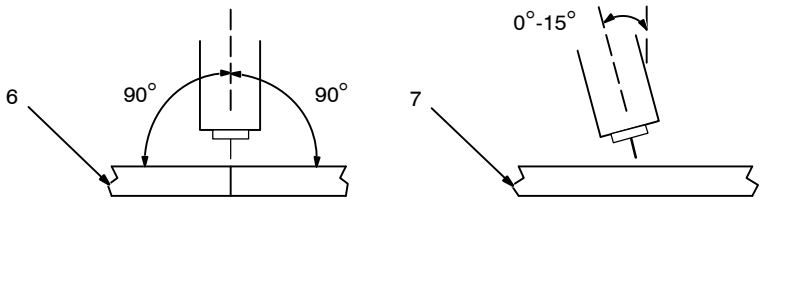

2-5. Conditions That Affect Weld Bead Shape

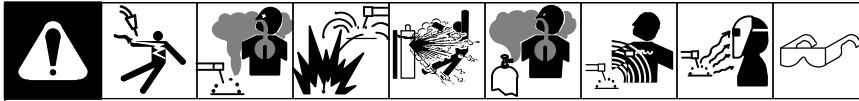

☞ Weld bead shape depends on gun angle, direction of travel, electrode extension (stickout), travel speed, thickness of base metal, wire feed speed (weld current), and voltage.

Gun Angles And Weld Bead Profiles

- 1 Push
- 2 Perpendicular
- 3 Drag

Electrode Extensions (Stickout)

- 4 Short
- 5 Normal
- 6 Long

Fillet Weld Electrode Extension (Stickout)

- 7 Short
- 8 Normal
- 9 Long

Gun Travel Speed

- 10 Slow
- 11 Normal
- 12 Fast

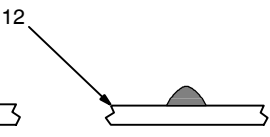
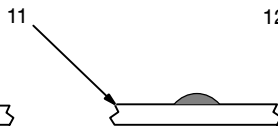
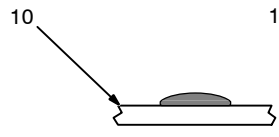
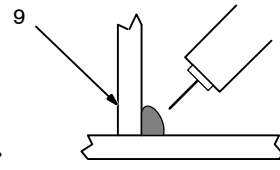
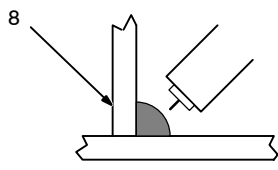
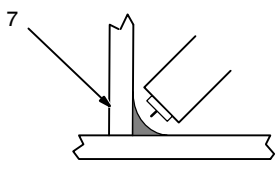
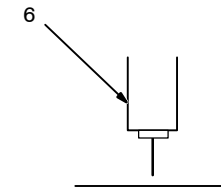
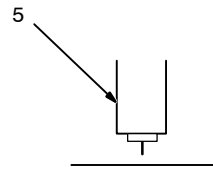
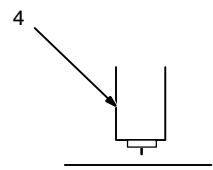
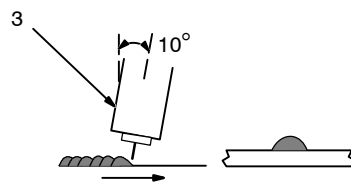
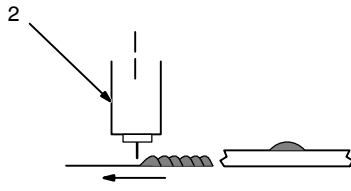
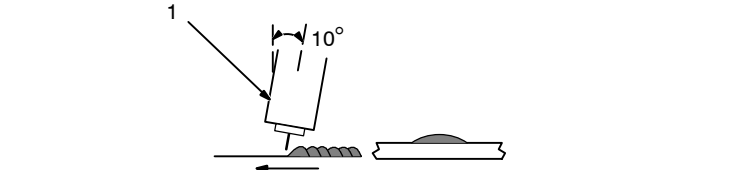

2-6. Gun Movement During Welding

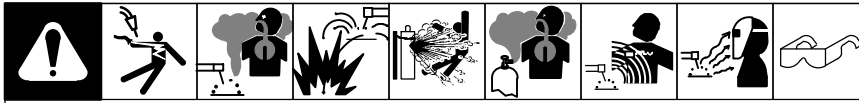

Normally, a single stringer bead is satisfactory for most narrow groove weld joints. However, for wide groove weld joints or bridging across gaps, a weave bead or multiple stringer beads works better.

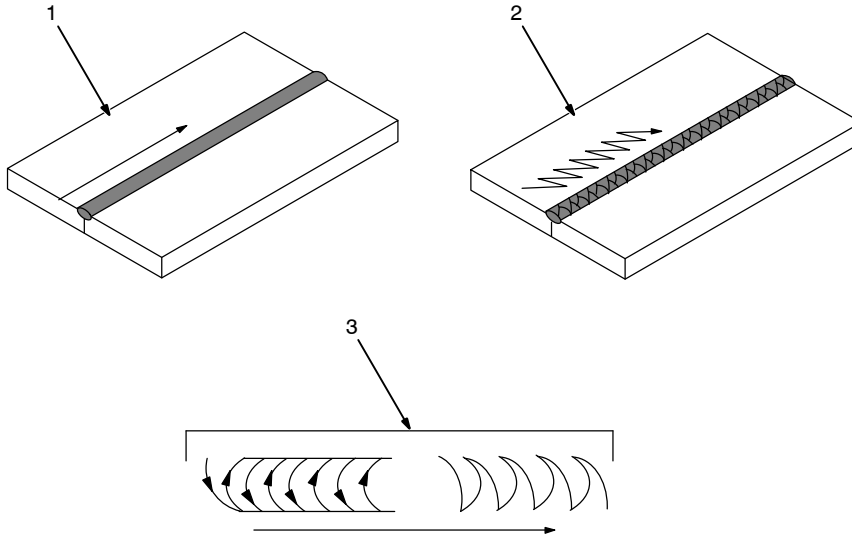

- 1 Stringer Bead – Steady Movement Along Seam
- 2 Weave Bead – Side To Side Movement Along Seam
- 3 Weave Patterns

Use weave patterns to cover a wide area in one pass of the electrode.

S-0054-A

2-7. Poor Weld Bead Characteristics

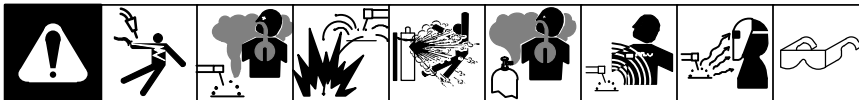

- 1 Large Spatter Deposits
- 2 Rough, Uneven Bead
- 3 Slight Crater During Welding
- 4 Bad Overlap
- 5 Poor Penetration

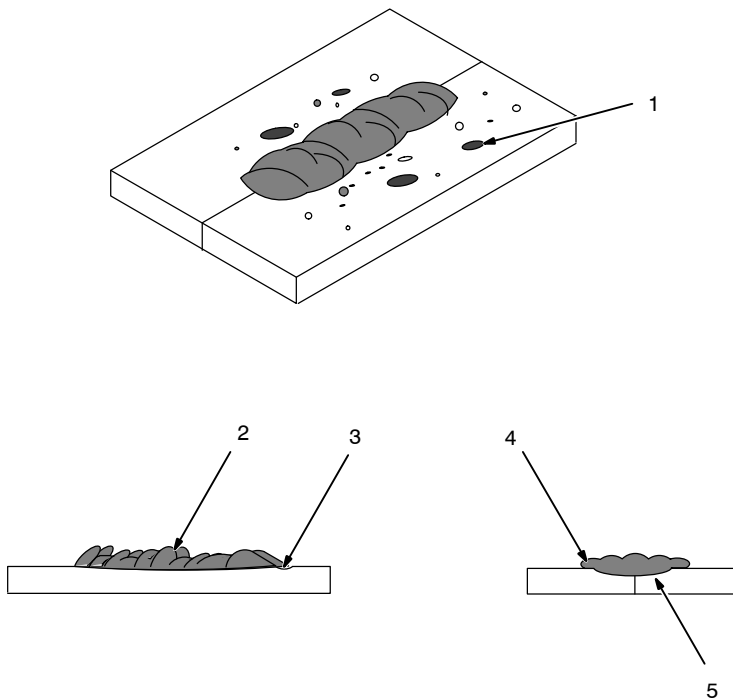

S-0053-A

2-8. Good Weld Bead Characteristics

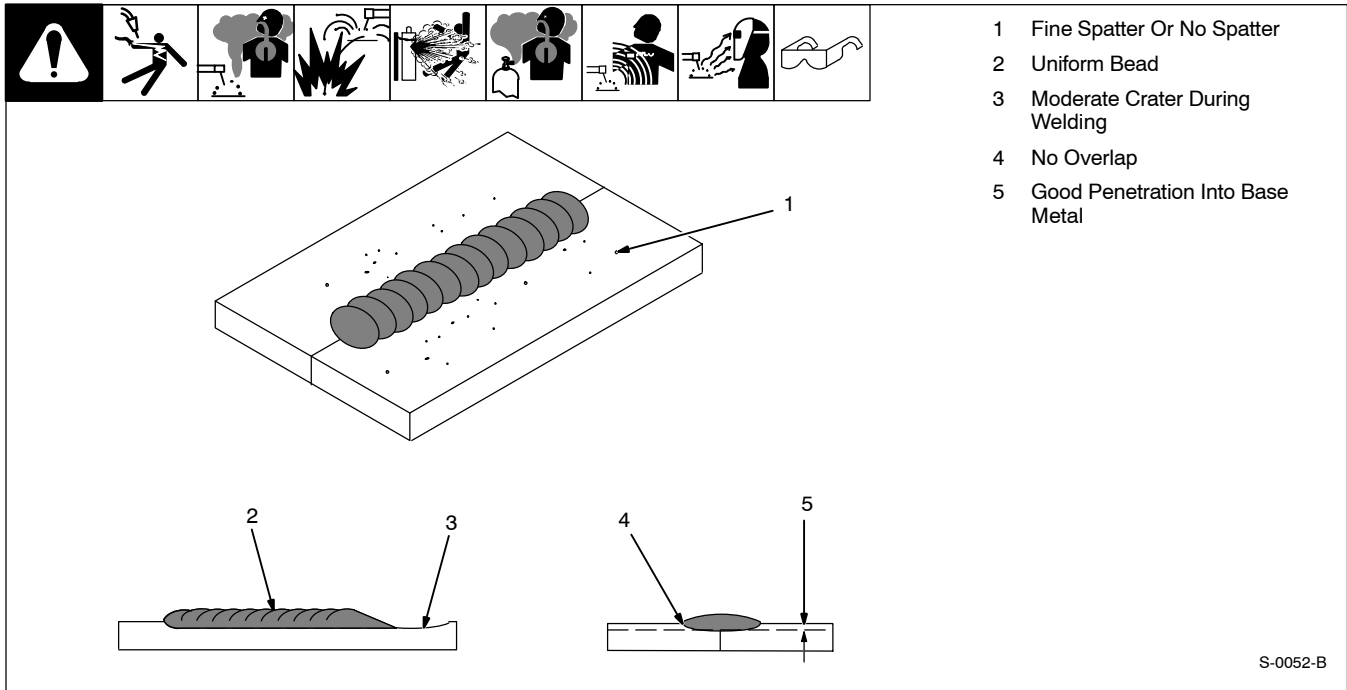

2-9. Common GMAW Shielding Gases

This is a general chart for common gases and where they are used. Many different combinations (mixtures) of shielding gases have been developed over the years.

Gas	Spray Arc Steel	Short Circuiting Steel	Spray Arc Stainless Steel	Short Circuiting Stainless Steel	Spray Arc Aluminum	Short Circuiting Aluminum
Argon					All Positions ⁵	All Positions
Argon + 1% O ₂	Flat & Horizontal ⁵ Fillet		Flat & Horizontal ⁵ Fillet			
Argon + 2% O ₂	Flat & Horizontal ⁵ Fillet		Flat & Horizontal ⁵ Fillet			
Argon + 5% O ₂	Flat & Horizontal ⁵ Fillet					
Argon + 8% CO ₂	Flat & Horizontal ⁵ Fillet	All Positions				
Argon + 25% CO ₂	Flat & Horizontal ¹ Fillet	All Positions				
Argon + 50% CO ₂		All Positions				
CO ₂	Flat & Horizontal ¹ Fillet	All Positions				
Helium					All Positions ²	
Argon + Helium					All Positions ²	
Tri-Mix ⁴				All Positions		

1 Globular Transfer
 2 Heavy Thicknesses
 3 Single Pass Welding Only

4 90% HE + 7-1/2% AR + 2-1/2% CO₂
 5 Also for GMAW-P, All Positions

SECTION 3 – MODES OF GMAW TRANSFER

☞ GMAW transfer mode is determined by variables such as shielding gas type, arc voltage, arc current, diameter of electrode and wire feed speed.

3-1. Short Circuit Transfer

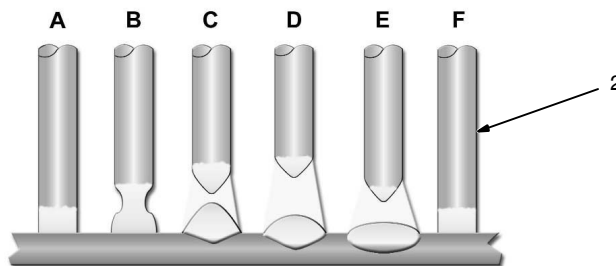
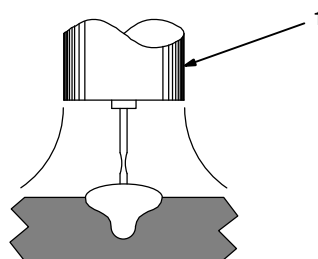
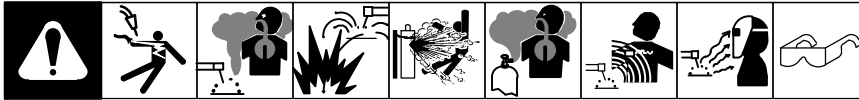

1 Short Circuit Transfer

Short circuit transfer refers to the welding wire actually “short circuiting” (touching) the base metal between 90 - 200 times per second.

With short circuit transfer, wire feed speeds, voltages, and deposition rates are usually lower than with other types of metal transfer such as spray transfer. This makes short circuit transfer very versatile allowing the welder to weld on thin or thick metals in any position.

Limitations of short circuit transfer:

- A relatively low deposition rate
- Lack of fusion on thicker metals
- More spatter

☞ Short circuit transfer usually has a crackling (bacon frying) sound when a good condition exists.

2 Short Circuit Cycle

A - Electrode is short circuited to base metal. No arc, and current is flowing through electrode wire and base metal.

B - Resistance increases in electrode wire causing it to heat, melt and “neck down”.

C - Electrode wire separates from weld puddle, creating an arc. Small portion of electrode wire is deposited which forms a weld puddle.

D - Arc length and load voltage are at maximum. Heat of arc is flattening the puddle and increasing the diameter tip of electrode.

E - Wire feed speed overcomes heat of arc and wire approaches base metal again.

F - Arc is off and the short circuit cycle starts again.

3-2. Globular Transfer

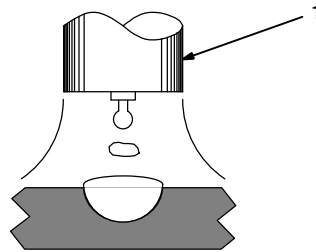
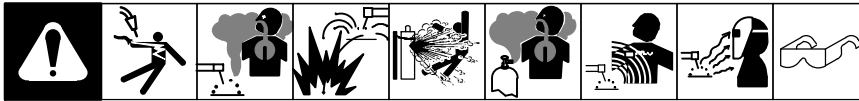

1 Globular Transfer

Globular transfer refers to the state of transfer between short-circuiting and spray arc transfer. Large globs of wire are expelled off the end of the electrode wire and enter the weld puddle.

Globular transfer can result when welding parameters such as voltage, amperage and wire feed speed are somewhat higher than the settings for short circuit transfer.

Limitations of globular transfer:

- Presence of spatter
- Less desirable weld appearance than spray arc transfer
- Welding is limited to flat positions and horizontally fillet welds
- Welding is limited to metal 1/8 inch (3 mm) or thicker

Ref. 804 879-A

3-3. Spray Arc Transfer

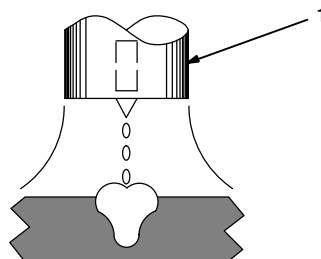
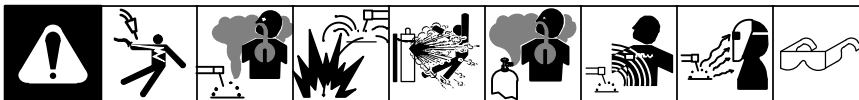

1 Spray Arc Transfer

Spray arc transfer “sprays” a stream of tiny molten droplets across the arc, from the electrode wire to the base metal.

Spray arc transfer uses relatively high voltage, wire feed speed and amperage values, compared to short circuit transfer.

To achieve a true spray transfer, an argon-rich shielding gas must be used.

When proper parameters are used, the spray arc transfer produces a characteristic humming or buzzing sound.

Advantages of spray arc transfer:

- High deposition
- Good fusion and penetration
- Good bead appearance
- Capability of using larger diameter wires

Presence of very little spatter

Limitations of spray arc transfer:

- Used only on material 1/8 inch (3 mm) and thicker (hand held)
- Limited to flat and horizontal fillet weld position (except for some spray transfer on aluminum)
- Good fit-up is always required as there is no open root capability

Ref. 804 879-A

SECTION 4 – GMAW WELDING TROUBLESHOOTING

4-1. Excessive Spatter

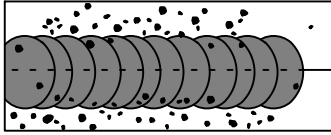

Excessive Spatter – scattering of molten metal particles that cool to solid form near weld bead.

Possible Causes	Corrective Actions
Wire feed speed too high.	Select lower wire feed speed.
Voltage too high.	Select lower voltage range.
Electrode extension (stickout) too long.	Use shorter electrode extension (stickout).
Workpiece dirty.	Remove all grease, oil, moisture, rust, paint, undercoating, and dirt from work surface before welding.
Insufficient shielding gas at welding arc.	Increase flow of shielding gas at regulator/flowmeter and/or prevent drafts near welding arc.
Dirty welding wire.	Use clean, dry welding wire.
	Eliminate pickup of oil or lubricant on welding wire from feeder or liner.

4-2. Porosity

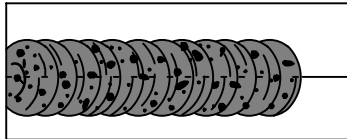

Porosity – small cavities or holes resulting from gas pockets in weld metal.

Possible Causes	Corrective Actions
Inadequate shielding gas coverage.	Check for proper gas flow rate.
	Remove spatter from gun nozzle.
	Check gas hoses for leaks.
	Eliminate drafts near welding arc.
	Place nozzle 1/4 to 1/2 in. (6-13 mm) from workpiece.
	Hold gun near bead at end of weld until molten metal solidifies.
Wrong gas.	Use welding grade shielding gas; change to different gas.
Dirty welding wire.	Use clean, dry welding wire.
	Eliminate pick up of oil or lubricant on welding wire from feeder or liner.
Workpiece dirty.	Remove all grease, oil, moisture, rust, paint, coatings, and dirt from work surface before welding.
	Use a more highly deoxidizing welding wire (contact supplier).
Welding wire extends too far out of nozzle.	Be sure welding wire extends not more than 1/2 in. (13 mm) beyond nozzle.

4-3. Incomplete Fusion

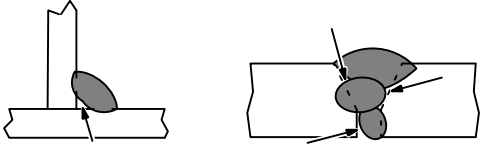
 <p>Incomplete Fusion – failure of weld metal to fuse completely with base metal or a preceding weld bead.</p>	
Possible Causes	Corrective Actions
Workpiece dirty.	Remove all grease, oil, moisture, rust, paint, coatings, and dirt from work surface before welding.
Insufficient heat input.	Select higher voltage range and/or adjust wire feed speed.
Improper welding technique.	Place stringer bead in proper location(s) at joint during welding.
	Adjust work angle or widen groove to access bottom during welding.
	Momentarily hold arc on groove side walls when using weaving technique.
	Keep arc on leading edge of weld puddle.
	Use correct gun angle of 0 to 15 degrees.

4-4. Excessive Penetration

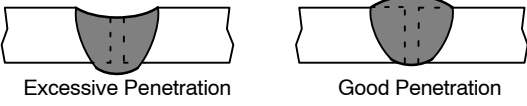
 <p>Excessive Penetration – weld metal melting through base metal and hanging underneath weld.</p>	
Possible Causes	Corrective Actions
Excessive heat input.	Select lower voltage range and reduce wire feed speed.
	Increase travel speed.

4-5. Lack Of Penetration

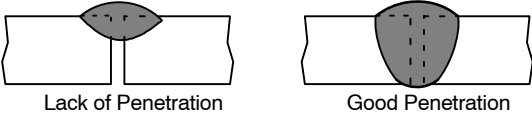
 <p>Lack Of Penetration – shallow fusion between weld metal and base metal.</p>	
Possible Causes	Corrective Actions
Improper joint preparation.	Material too thick. Joint preparation and design must provide access to bottom of groove while maintaining proper welding wire extension and arc characteristics.
Improper weld technique.	Maintain normal gun angle of 0 to 15 degrees to achieve maximum penetration.
	Keep arc on leading edge of weld puddle.
	Be sure welding wire extends not more than 1/2 in. (13 mm) beyond nozzle.
Insufficient heat input.	Select higher wire feed speed and/or select higher voltage range.
	Reduce travel speed.

4-6. Burn Through

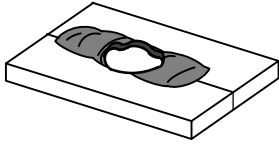

Burn-Through – weld metal melting completely through base metal resulting in holes where no metal remains.

Possible Causes	Corrective Actions
Excessive heat input.	Select lower voltage range and reduce wire feed speed.
	Increase and/or maintain steady travel speed.

4-7. Waviness Of Bead

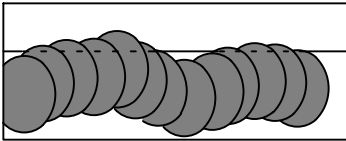

Waviness Of Bead – weld metal that is not parallel and does not cover joint formed by base metal.

Possible Causes	Corrective Actions
Unsteady hand.	Support hand on solid surface or use two hands.

4-8. Distortion

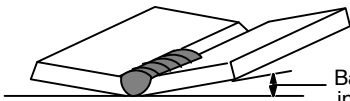

Distortion – contraction of weld metal during welding that forces base metal to move.

Possible Causes	Corrective Actions
Excessive heat input.	Use restraint (clamp) to hold base metal in position.
	Make tack welds along joint before starting welding operation.
	Select lower voltage range and/or reduce wire feed speed.
	Increase travel speed.
	Weld in small segments and allow cooling between welds.

Miller Electric Mfg. Co.

An Illinois Tool Works Company
1635 West Spencer Street
Appleton, WI 54914 USA

International Headquarters—USA

USA Phone: 920-735-4505 Auto-Attended
USA & Canada FAX: 920-735-4134
International FAX: 920-735-4125

For International Locations Visit
www.MillerWelds.com

